

1400

2018

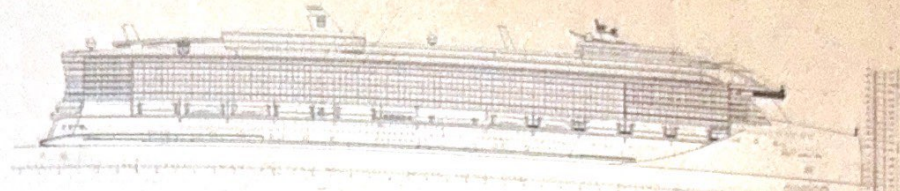

2019

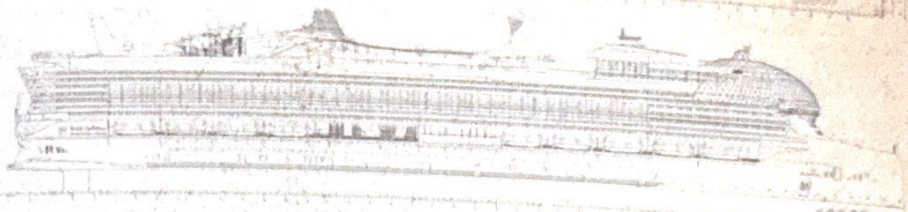

2020

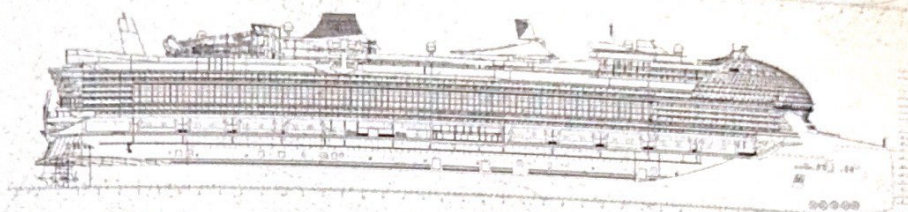

2021

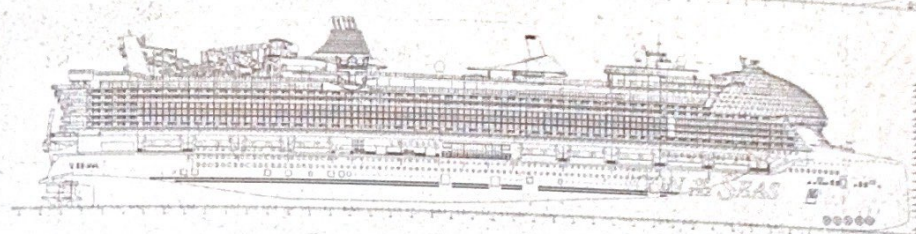

2023

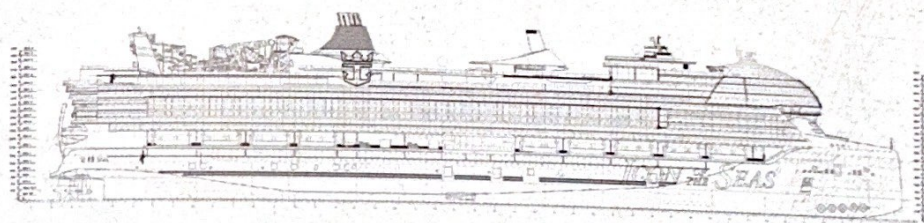

THE STORY OF 1400 LOBBY BAR

The 1400 Lobby Bar is dedicated to the art of innovation pioneered at Royal Caribbean and is an homage to the first name given to Icon of the Seas by the builder in Turku, Finland - NB 1400.

Icon is an achievement that is a testament to the teams from around the world that spent years tirelessly working to make her a reality. She is also the celebration of over 50 years of innovation that started all the way back in 1970 with the Song of Norway.

The Beginning - Song of Norway

After the founding of Royal Caribbean in 1968, the development of the first purpose-built cruise ship began. The Song of Norway was launched in 1970, featuring an innovative design tailored for warm-weather cruising.

NB 392

The Song of Norway
Built 1970
Helsinki, Finland

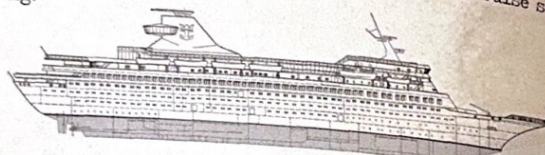

The Song of Norway charted a new course for the industry, closing the doors on the age of ocean liners and ushering in the era of the modern-day cruise ship.

NOTABLE FEATURES

Dedicated pool deck and sun decks
First Viking Crown Lounge

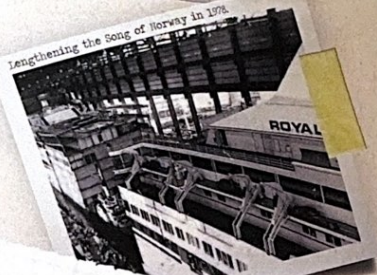

Lengthening the Song of Norway in 1978

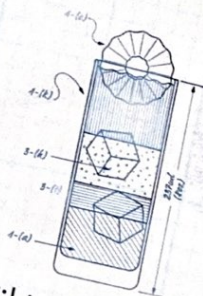
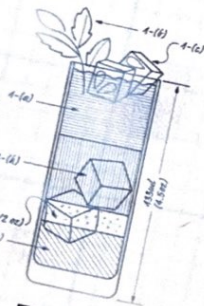

The First Song

Casamigos Silver tequila, Cointreau, watermelon juice and lemon sour

14

Viking's Crown

Pisco, lemon and pineapple juices and pineapple gum syrup

14

Next Up - Song of America ...and the Sovereign Class

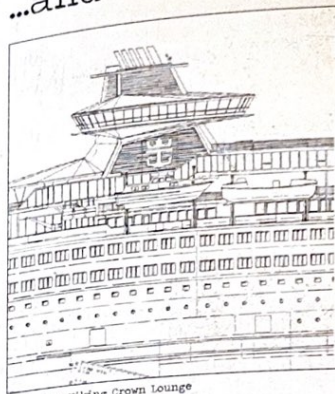

360-degree Viking Crown lounge

NB 431

The Song of America
Built 1982
Helsinki, Finland

NOTABLE FEATURES

360-degree Viking Crown Lounge
Expansive Pool Deck

Next in development was the Song of America, a ship larger than her sisters and featuring a new and improved Viking Crown Lounge positioned around the ship's funnel - a design so iconic that it lasts to this day and is featured by many in Royal Caribbean's fleet.

As the need for construction grew, Royal Caribbean expanded the builder network throughout Europe, including the Sovereign class, the first megaships built by Royal Caribbean in Saint-Nazaire, France.



SOVEREIGN OF THE SEAS - SONG OF AMERICA - SONG OF NORWAY - VIKING CROWN - SAVINING
ROYAL CARIBBEAN
When you're ready for something better
The evolution of the Viking Crown from the Song of Norway to Sovereign of the Seas

NB A-29

Sovereign of the Seas
Built 1987
Saint-Nazaire, France

NOTABLE FEATURES

The Centrum



The Song of America

Sail safely. Please drink responsibly. An 18% gratuity will be added for certain ports or itineraries. VAT may apply for certain ports or itineraries.

The Millennium - Voyager Class

Voyager of the Seas (Project Eagle) was the largest cruise ship in the world (at that time, built in Turku, Finland in 1999).

Voyager ushered Royal Caribbean International into the new millennium and set the new standard for cruising, with the tag line "Like no vacation on earth!"

NB 1344

Voyager of the Seas
Built 1999
Turku, Finland

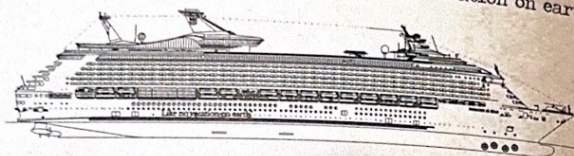

NOTABLE FEATURES

- The Royal Promenade
- Mini-golf
- Studio B
the first ice skating rink at sea
- Rock wall
the first at sea
- On Air!
- A full basketball court
- 3-deck high Main Dining Room
- Adventure Beach
featuring our first waterslide at sea
- Inline skating rink

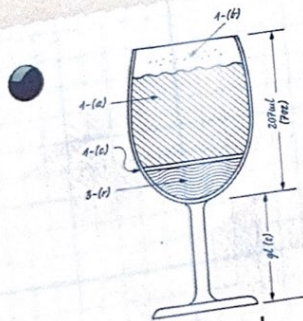

The Eagle

Hennessy V.S cognac, milk, vanilla and simple syrup with a sprinkle of nutmeg

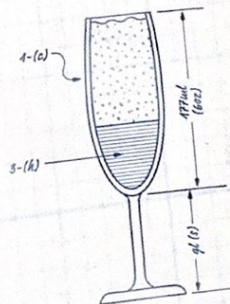

Millennium Bellini

Santa Elvira Prosecco and peach purée

The Era of Thrill - Freedom Class

Freedom of the Seas bears resemblance to her older sisters, featuring the same structure, shape, and lines of the earlier Voyager Class. However, the secret to Freedom is that she is one

fire zone longer, giving an additional 91 feet of real estate for features and amenities that guests were asking for, and the thrills they least expect.

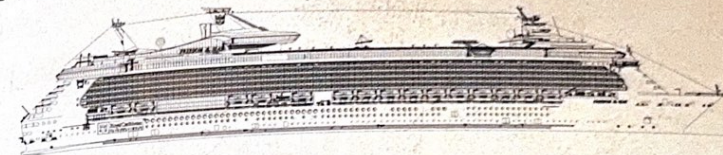

NB 1352

Freedom of the Seas
Built 2006
Turku, Finland

NOTABLE FEATURES

- An expanded Royal Promenade
- The Flowrider
the first surf simulator at sea
- H2O Zone
the original Splashaway Bay
- Cantilevered whirlpools
- The first boxing ring at sea

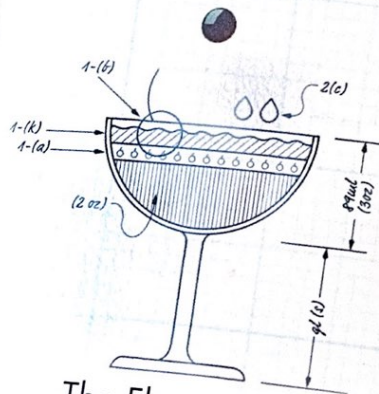

The Flowrider

Jack Daniel's Tennessee rye, Heering cherry liqueur, Lillet Blanc and Angostura orange bitters



The Original Gamechanger - Oasis Class

The Oasis Class (Project Genesis) took the industry by storm when Oasis of the Seas debuted in 2009. Oasis, and her sister Allure, rewrote the playbook on what it meant to be a modern cruise ship, featuring jaw-dropping WOWs that have since become a staple for

Royal Caribbean International Oasis was the first time a ship's superstructure was split down the middle, creating open-air atriums in more areas of the ship giving our designers more room to innovate and revolutionize our guest experience.



First Carousel at Sea

NOTABLE FEATURES

7 distinct neighborhoods, including

Central Park
Boardwalk

AquaTheater
the first at sea

Carousel
the first at sea

The Rising Tide Bar
the first moving bar at sea

Dual Flowriders

Loft Suites

The Ultimate Abyss
[later addition]

Perfect Storm
Waterslides
[later addition]

Ultimate Family Suite
[later addition]

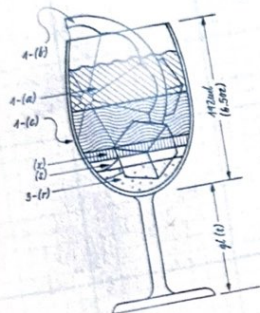

Pink Pony

Absolut Citron vodka, St-Germain Elderflower liqueur, Aperol, grapefruit juice and lemon sour
14

NB 1363

Oasis of the Seas
Built 2009
Turku, Finland

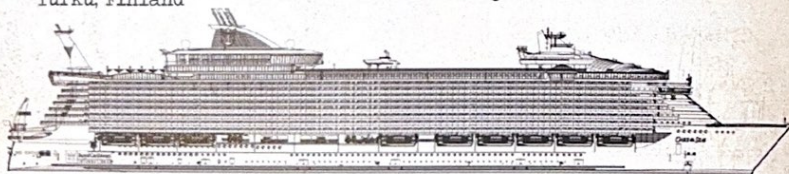

Central Park

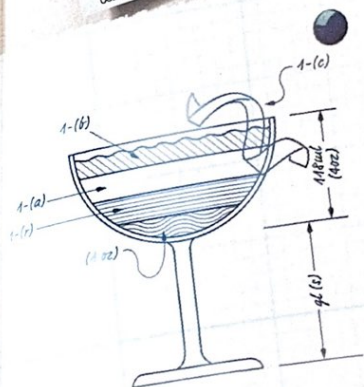

Rising Tides

Bombay Sapphire gin, Lillet Blanc, Cointreau, absinthe and lemon sour
14

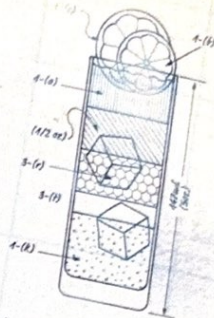

Living Garden

Ketel One Botanical Grapefruit & Rose vodka, Aperol, honey syrup, lemon and orange juice
14

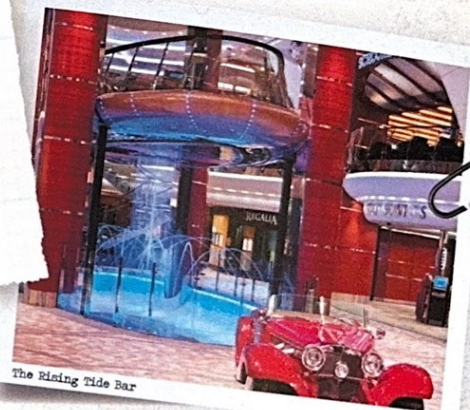

The Rising Tide Bar

Sail safely. Please drink responsibly. An 18% gratuity will be added for certain ports or itineraries. VAT may apply for certain ports or itineraries.

The Smartest Ship - Quantum Class

Debuting in 2014, Quantum of the Seas became Royal Caribbean International's smartest ship of the 21st century, featuring many futuristic firsts rarely seen, even on land. This class was expanded in 2018 with the introduction of Quantum-Ultra ships, Spectrum of the Seas and Odyssey of the Seas, that added new experiences and versatility to this globetrotting ship class.

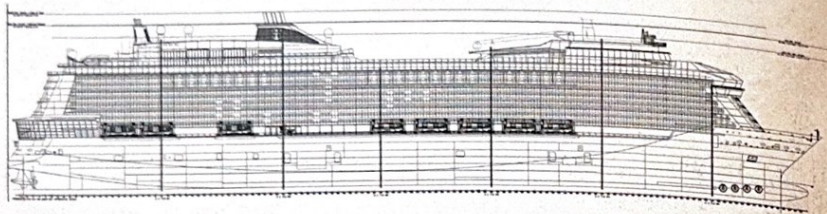

NB S-697

Quantum of the Seas
Built 2014
Papenburg, Germany

NOTABLE FEATURES

- Bionic Bar**
the first at sea
- Ripcord by iFLY**
the first indoor skydiving at sea
- The NorthStar**
an elevated glass capsule with 360° views - the first at sea
- The SeaPlex**
featuring the first bumper cars at sea
- Two70**
cutting-edge theater with a 270° view

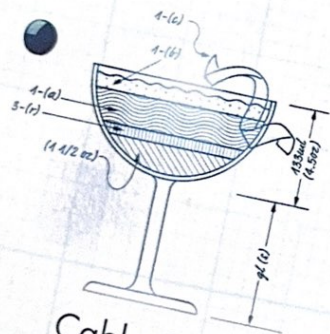

Cable Car

Captain Morgan's Original Spiced rum,
orange curaçao, lemon sour and
aquafaba with a cinnamon sugar rim

14

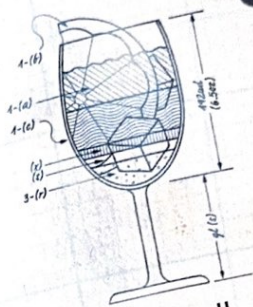

Free Fall

Ketel One Botanical Orange Blossom vodka,
Campari, Cointreau, blood orange purée,
lemon sour and soda water

14



The North Star



Ripcord by iFLY



The SeaPlex

Sail safely. Please drink responsibly. An 18% gratuity will be added for certain ports or itineraries. VAT may apply for certain ports or itineraries.

The Future of Vacations - Icon of the Seas

Icon of the Seas (Project ICON) set out to revolutionize the entire vacation industry, bringing together the best of resorts, theme parks and our 50+ years of innovation to create the best family vacation on the planet. Icon offers unparalleled experiences for each member of the family, with more ways to chill, and more ways to thrill, than ever before.



Surfside

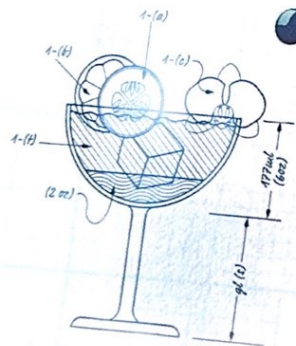

Iconic G&T

Bombay Sapphire gin and Iconic Tonic

14

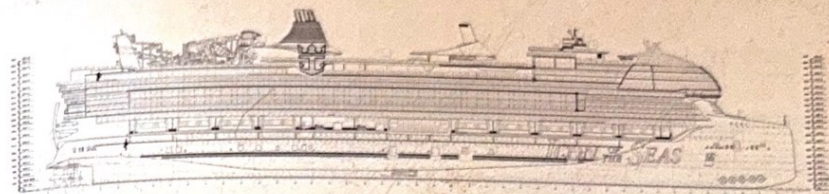

NOTABLE FEATURES

8 distinct neighborhoods, including

The AquaDome
the largest freestanding dome at sea

The Hideaway
featuring the first suspended infinity pool at sea

Thrill Island
first neighborhood dedicated to all things Thrill

Chill Island
featuring the largest pool at sea

Surfside
the first neighborhood dedicated for young families

The Pearl
the world's largest kinetic sculpture

Category 6 Waterpark
the largest water park at sea

Crown's Edge
a first-of-its-kind thrilling over-water attraction

Ultimate Family Townhouse
the most fun stateroom in the fleet

Royal Bay
the largest pool at sea

The first LNG ship in the fleet

--And much more!

NB 1400

Icon of the Seas

Built 2023

Turku, Finland

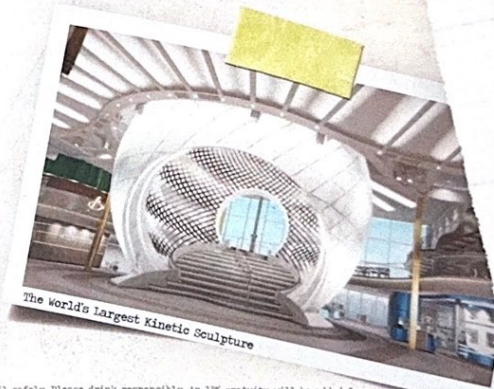

The World's Largest Kinetic Sculpture

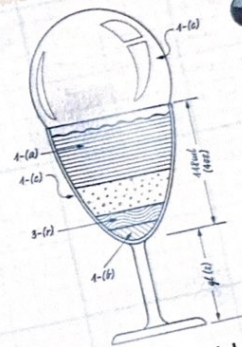

The Fourteen Hundred
Casamigos Blanco tequila, Italicus liqueur,
pearl shimmer syrup and lemon sour
with a citrus bubble

14

Wine

Sparkling

- 223 Chandon, Brut "Classic"
California, USA
- 980 Santa Elvira, Prosecco
Veneto, Italy

White/Rosé

- 295 Beringer, White Zinfandel
California, USA
- 502 Château d'Esclans, Rosé
Côtes de Provence, "Whispering Angel"
Provence, France
- 343 Kim Crawford, Sauvignon Blanc
Marlborough, New Zealand
- 248 Danzante, Pinot Grigio
Delle Venezie, Italy
- 939 Kendall-Jackson, Chardonnay,
"Vintner's Reserve"
California, USA
- 639 Château d'Aussières, Chardonnay,
"Aussières," Vin de Pays d'Oc
Languedoc, France

glass bottle

12 58

8 40

8 29

14 55

12 54

10 40

11 42

9 33

Red

- 709 Estancia, Pinot Noir
Monterey County, California, USA
- 503 Terrazas de los Andes, Malbec
Mendoza, Argentina
- 995 Vint by Robert Mondavi, Merlot
California, USA
- 687 Château d'Aussières, Cabernet Sauvignon,
"Aussières," Vin de Pays d'Oc
Languedoc, France
- 987 Murphy-Goode, Cabernet Sauvignon,
California, USA

glass bottle

12 47

14 56

12 45

9 33

11 42

Beer

- Coors Light 7.49
- Corona Extra 7.99
- Heineken 7.99
- Michelob Ultra 7.49
- Voodoo Ranger
- Juicy Haze IPA 7.99

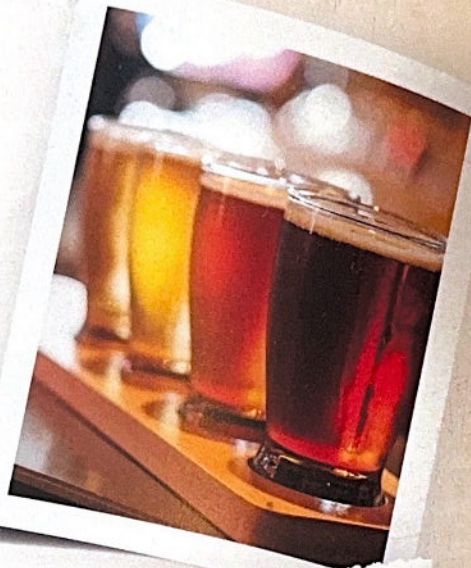

Other

- White Claw Hard Seltzer 7.49
Mango
- Twisted Tea Hard Iced Tea 7.49
- Heineken 0.0 (Non-Alc) 6.99

Zero Proof Non-Alcoholic

Coconut Lime Refresher
Lime juice, lemonade,
coconut syrup and mint ?

Tiger's Tale
Lemon juice, coconut syrup,
watermelon syrup, club soda, mint,
strawberry and watermelon ?

Passion Starlight
Lemon juice, pineapple juice,
lemonade, passion fruit syrup
and mint ?

Blueberry Nojito
Blueberry purée, lime juice,
simple syrup and mint ?



Call safely. Please drink responsibly. An 18% gratuity will be added for certain ports or itineraries. VAT may apply for certain ports or itineraries.